

HOOYI®

Archery & Hunting

HOOYI Archery Supply "Leading the World in 3D & Target Archery"

Since
2007

www.hooyiarchery.com

Arrows

Arrow Componets

Broadheads

Stabilizer System

Shooting Gear

2022 Catalog

HOOYI®

1-1307 GUOTAI BUILDING WENCHANG WEST ROAD

YANGZHOU CITY JIANGSU 225009 CHINA

T:86-514-8558 6249

SALES@SOURCEPRO.CN

www.hooyiarchery.com

COMPANY INFORMATION

HOOYI is committed to providing a professional and high quality product. With over 10 years of business experience, we are fully-equipped and dedicated to quality in all aspects of what we do: Manufacturing and Researching, Design and Quality Controlling.

HOOYI has professional marketing team, great marketing strategy and management programs in market development and sales. In the meantime we are expanding our product line, to give our customers more and more excellent product.

This site is designed to give you an insight into the type of product we provide, so if you are searching for an archery product that is not listed please contact us we can do customized for you.

WHY PARTNER WITH HOOYI ARCHERY?

HOOYI Archery is a large-scale archery components factory which is specialized in the development, customized and production of mostly components in archery, especially arrow and broadheads.

Our main technology is CNC Machined, Powder Metallurgy, Rolling and Injection Molding. In the production process, the production management department manage the production in accordance with standard procedure as well as using harsh quality requirements and testing standards, we can ensure that consumers can really enjoy our quality during the monitoring of the whole production process.



Provide OEM&ODM

- Minor Customization
- Customization from Designs.
- Customization from Samples
- Full Customization



Strong Professional Ability

- Senior seller, Global Export Expertise.
- Industry Experience 15 Years.
- Famous Brands Supplier
- Articipate in Overseas offline Exhibitions



Our Service

- Centralized Procurement Available
- Immediate Respose
- Multilingual Communication
- Fast Delivery



WWW.HOOYIARCHERY.COM

**WE SHARE OUR PASSION FOR ARCHERY WITH YOU
NOW INTRODUCING OUR PRODUCTS TO YOU**



DIY ARROW

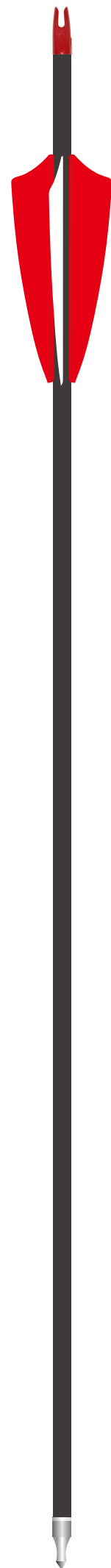

CARBON FIBER ARROW

Item number | HI-CN001

Carbon Arrow | Black

Material:

- Mixed Carbon

Length:

- 28-32"

Shaft ID:

- 0.244"/6.2mm

Shaft OD:

- 0.309"/7.85mm

Point:

- 100gr field points (Removable)

Fletching(Vanes):

- Length: 3"

- Shape: Parabolic/Shield

- Colour: white, black, red,green,
blue,orange,yellow,

Nock:

- Insert Nock

- Colour: white, black, red,green,
blue,orange,yellow

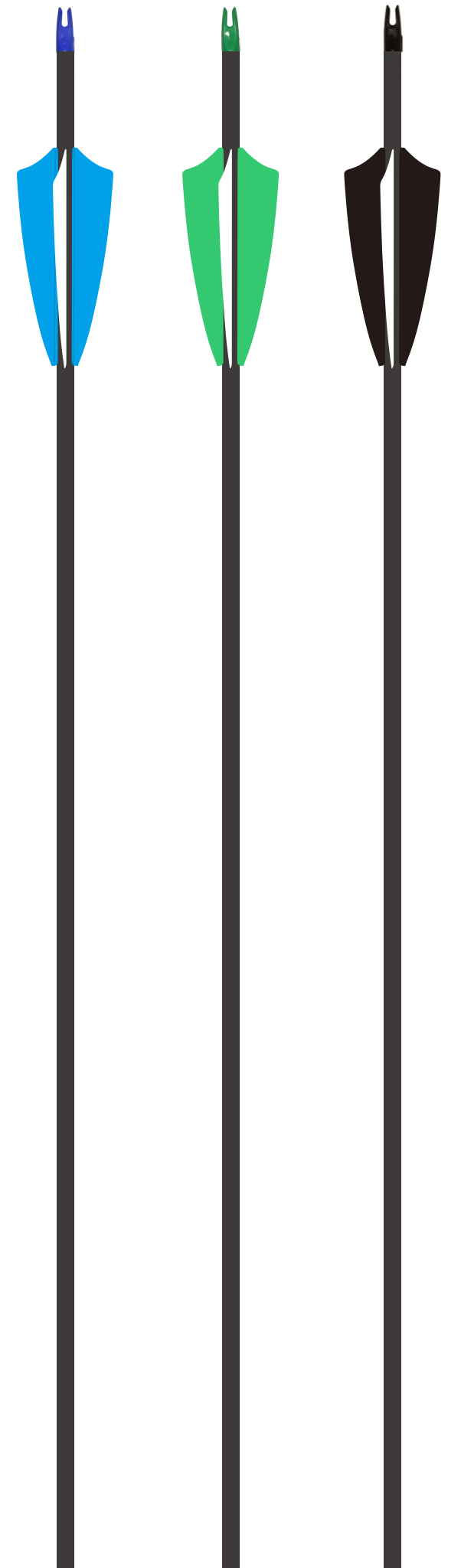

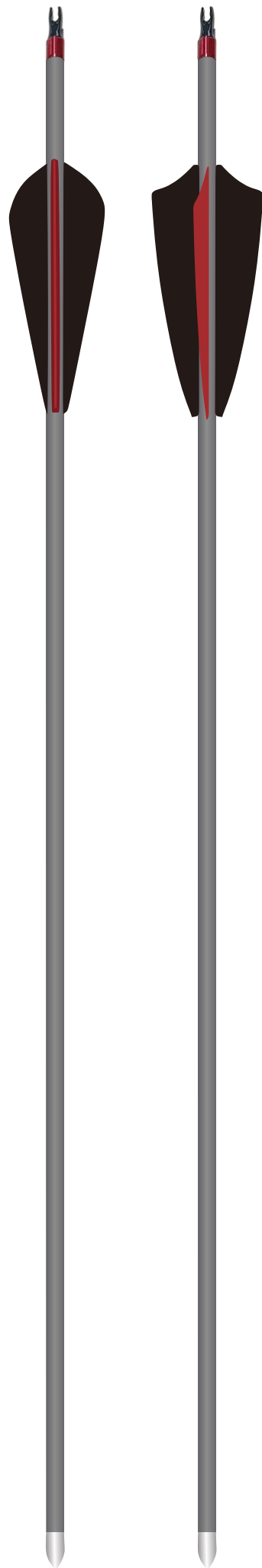

PURE CARBON ARROW

Item number | HI-CN002

Carbon Arrow | Grey

Material:

- 24T Pure Carbon

Length:

- 30-32"

Point:

- Glue in

fletching(Vanes):

- Length: 3"

- Shape: Parabolic/Shield

- Colour: white, black, red,green,
blue,orange,yellow,

Nock:

- Insert Nock

- Colour: white, black, red,green,
blue,orange,yellow

ID (Inch/mm)	OD (Inch/mm)	Spine	GPI	Straightness
0.165"/4.2	0.259"/6.58	250	12.20	0.001"/0.003"/0.006"
0.165"/4.2	0.251"/6.38	300	10.90	0.001"/0.003"/0.006"
0.165"/4.2	0.245"/6.22	350	9.90	0.001"/0.003"/0.006"
0.165"/4.2	0.239"/6.06	400	8.90	0.001"/0.003"/0.006"
0.165"/4.2	0.234"/5.94	500	8.30	0.001"/0.003"/0.006"
0.165"/4.2	0.227"/5.77	600	7.30	0.001"/0.003"/0.006"
0.165"/4.2	0.220"/5.60	700	6.60	0.001"/0.003"/0.006"
0.165"/4.2	0.217"/5.52	800	6.10	0.001"/0.003"/0.006"
0.165"/4.2	0.212"/5.39	900	5.30	0.001"/0.003"/0.006"
0.165"/4.2	0.209"/5.32	1000	5.00	0.001"/0.003"/0.006"
0.165"/4.2	0.207"/5.20	1100	4.60	0.001"/0.003"/0.006"

PURE CARBON ARROW

Item number | HI-CN003

Carbon Arrow | Grey

Material:

- 24T Pure Carbon

Length:

- 30-32"

Point:

- 100gr field points (Removable)

Fletching(Vanes):

- Length: 3"

- Shape: Parabolic/Shield

- Colour: white, black, red,green,
blue,orange,yellow,

Nock:

- Insert Nock

- Colour: white, black, red,green,
blue,orange,yellow

ID (Inch/mm)	OD (Inch/mm)	Spine	GPI	Straightness
0.244"/6.2mm	0.300"/7.62	300	9.30	0.001"/0.003"/0.006"
0.244"/6.2mm	0.297"/7.55	350	8.90	0.001"/0.003"/0.006"
0.244"/6.2mm	0.293"/7.43	400	8.00	0.001"/0.003"/0.006"
0.244"/6.2mm	0.287"/7.28	500	6.90	0.001"/0.003"/0.006"
0.244"/6.2mm	0.279"/7.08	600	5.50	0.001"/0.003"/0.006"
0.244"/6.2mm	0.276"/7.02	700	5.20	0.001"/0.003"/0.006"
0.244"/6.2mm	0.275"/6.99	800	5.00	0.001"/0.003"/0.006"

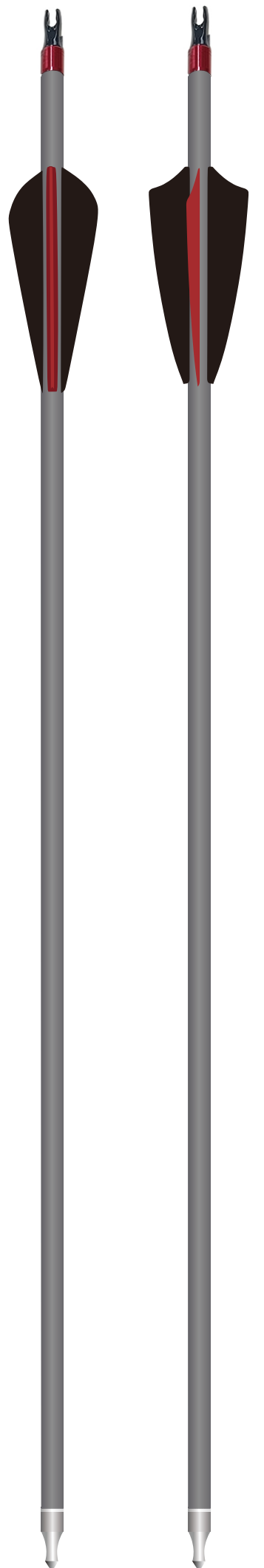

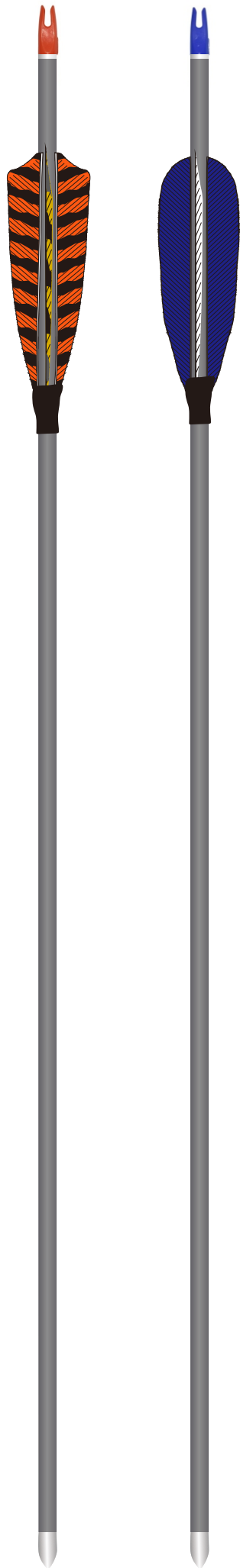

PURE CARBON ARROW

Item number | HI-CN004

Carbon Arrow | Grey

Material:

- 24T Pure Carbon

Length:

- 30-32"

Point:

- Glue in

Fletching(Vanes):

- Length: 4"

- Shape: Parabolic/Shield (With Turkey Feather)

- Colour: white, black, red,green,
blue,orange,yellow,

Nock:

- Insert Nock

- Colour: white, black, red,green,
blue,orange,yellow

ID (Inch/mm)	OD (Inch/mm)	Spine	GPI	Straightness
0.165"/4.2	0.259"/6.58	250	12.20	0.001"/0.003"/0.006"
0.165"/4.2	0.251"/6.38	300	10.90	0.001"/0.003"/0.006"
0.165"/4.2	0.245"/6.22	350	9.90	0.001"/0.003"/0.006"
0.165"/4.2	0.239"/6.06	400	8.90	0.001"/0.003"/0.006"
0.165"/4.2	0.234"/5.94	500	8.30	0.001"/0.003"/0.006"
0.165"/4.2	0.227"/5.77	600	7.30	0.001"/0.003"/0.006"
0.165"/4.2	0.220"/5.60	700	6.60	0.001"/0.003"/0.006"
0.165"/4.2	0.217"/5.52	800	6.10	0.001"/0.003"/0.006"
0.165"/4.2	0.212"/5.39	900	5.30	0.001"/0.003"/0.006"
0.165"/4.2	0.209"/5.32	1000	5.00	0.001"/0.003"/0.006"
0.165"/4.2	0.207"/5.20	1100	4.60	0.001"/0.003"/0.006"

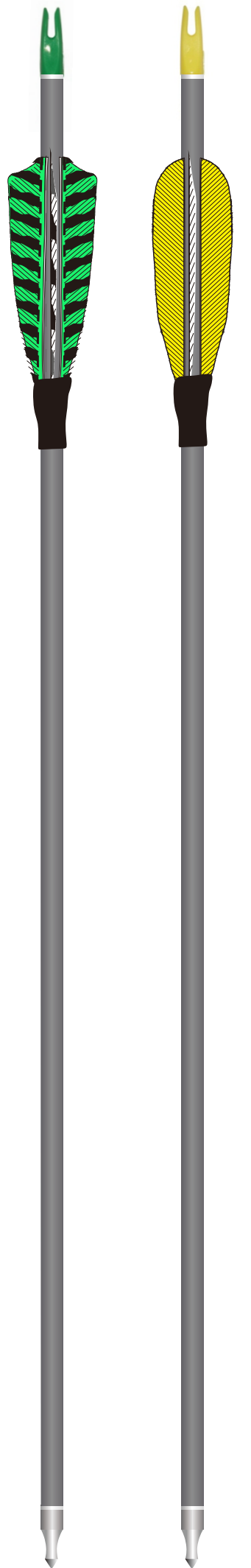

PURE CARBON ARROW

Item number | HI-CN005

Carbon Arrow | Grey

Material:

- 24T Pure Carbon

Length:

- 30-32"

Point:

- 100gr field points (Removable)

Fletching(Vanes):

- Length: 4"

- Shape: Parabolic/Shield (With Turkey Feather)

- Colour: white, black, red,green,
blue,orange,yellow,

Nock:

- Insert Nock

- Colour: white, black, red,green,
blue,orange,yellow

ID (Inch/mm)	OD (Inch/mm)	Spine	GPI	Straightness
0.244"/6.2mm	0.300"/7.62	300	9.30	0.001"/0.003"/0.006"
0.244"/6.2mm	0.297"/7.55	350	8.90	0.001"/0.003"/0.006"
0.244"/6.2mm	0.293"/7.43	400	8.00	0.001"/0.003"/0.006"
0.244"/6.2mm	0.287"/7.28	500	6.90	0.001"/0.003"/0.006"
0.244"/6.2mm	0.279"/7.08	600	5.50	0.001"/0.003"/0.006"
0.244"/6.2mm	0.276"/7.02	700	5.20	0.001"/0.003"/0.006"
0.244"/6.2mm	0.275"/6.99	800	5.00	0.001"/0.003"/0.006"



FIBERGLASS ARROW

Item number | HI-FA001

Carbon Arrow | Black

Material:

- Fiberglass

Length:

- 28-31"

Shaft OD:

-6mm/7mm

Point:

- Glue on

Fletching(Vanes):

- Length: 3"

- Shape: Parabolic/Shield

- Colour: white, black, red,green,
blue,orange,yellow,

Nock:

- Glue on Nock

- Colour: white, black, red,green,
blue,orange,yellow

FIBERGLASS ARROW

Item number | HI-FA002

Carbon Arrow | Black

Material:

- Fiberglass

Length:

- 30-31"

Shaft ID:

-6mm

Shaft OD:

-8mm

Point:

- Insert in 100gr field points (Removable)

Fletching(Vanes):

- Length: 3"

- Shape: Parabolic/Shield

- Colour: white, black, red,green,
blue,orange,yellow,

Nock:

- Insert Nock

- Colour: white, black, red,green,
blue,orange,yellow

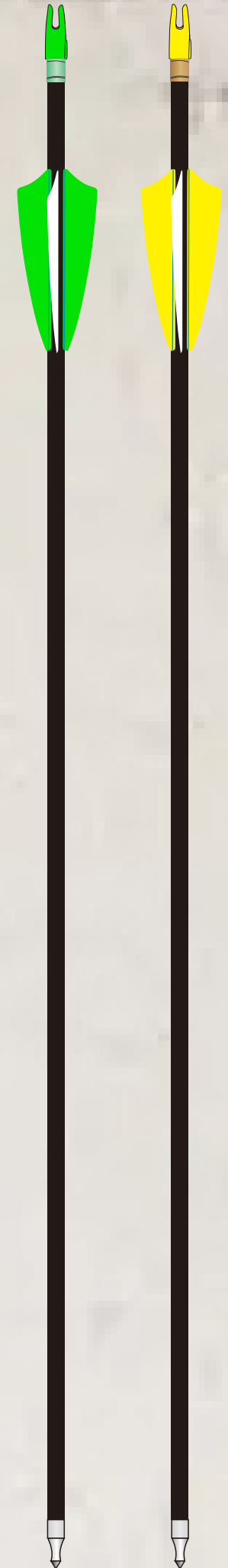

CROSSBOW ARROW

Item number	Length	ID (Inch/mm)	OD (Inch/mm)
HI-CA001	16"-22"	0.299"/7.62mm	0.346"/8.8mm

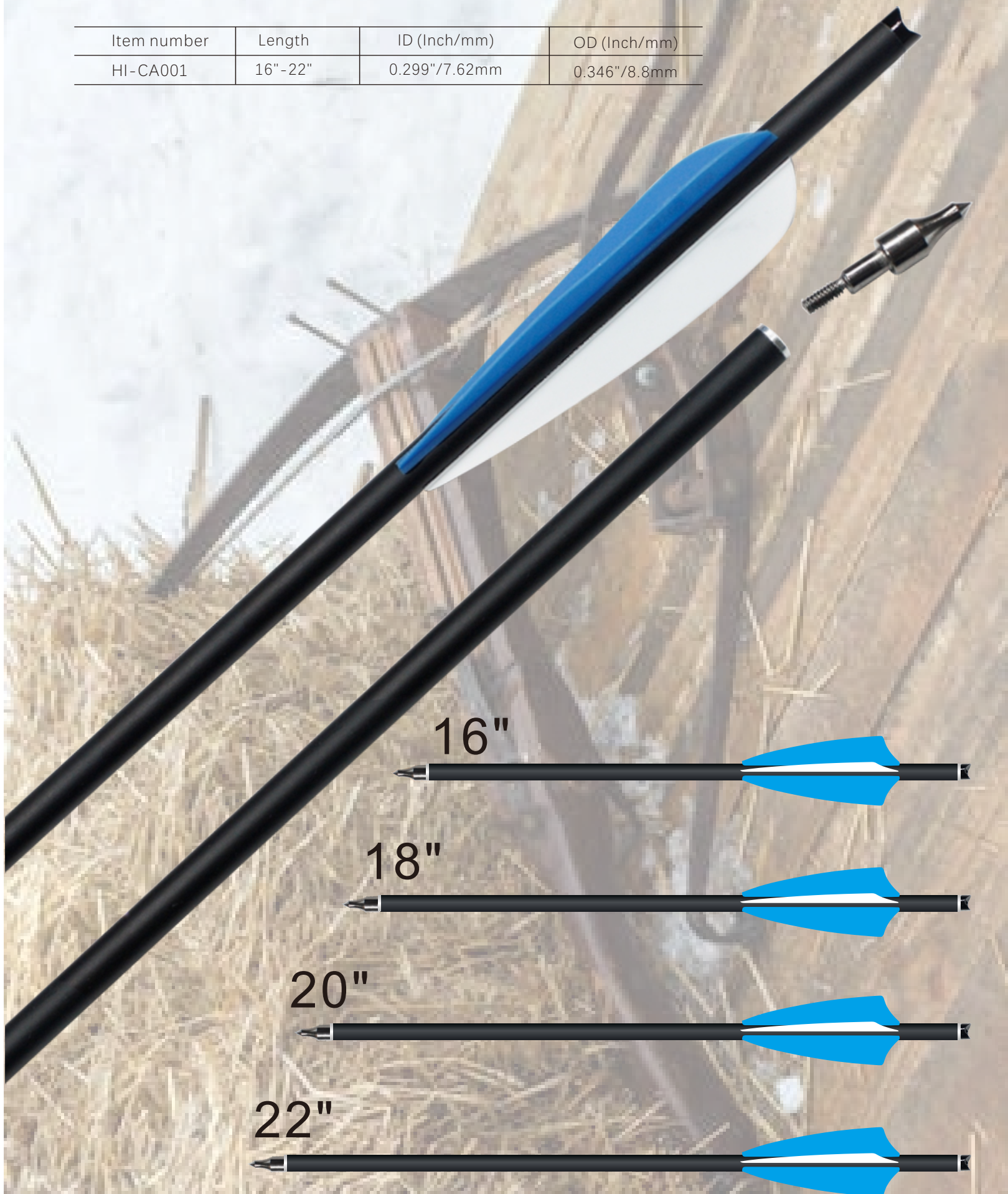

PISTOL CROSSBOW BOLTS



Item number | HI-PCB001

Material:

- Aluminum

Length:

- 6.3" /160mm

Vane:

-Plastic

Color:

- Gold/Red/Silver/Black/Green



Item number | HI-PCB002

Material:

- Plastic

Length:

- 6.3" /160mm

Vane:

-Plastic

Color:

- Yellow/Black/Orange/Blue/Green



We could make the different color, and print the logo on the shaft.



Item number | HI-BFA

Material:
- Solid Fiberglass

Overall Length:
- 32.5" / 82.7mm

Shaft Length:
- 30.5" / 77.3mm

Shaft OD:
- 8mm

Installation:
- Glued on Arrowheads

Arrowhead weight:
- 18g

Arrow weight:
- 100g

Arrow Shaft Colors

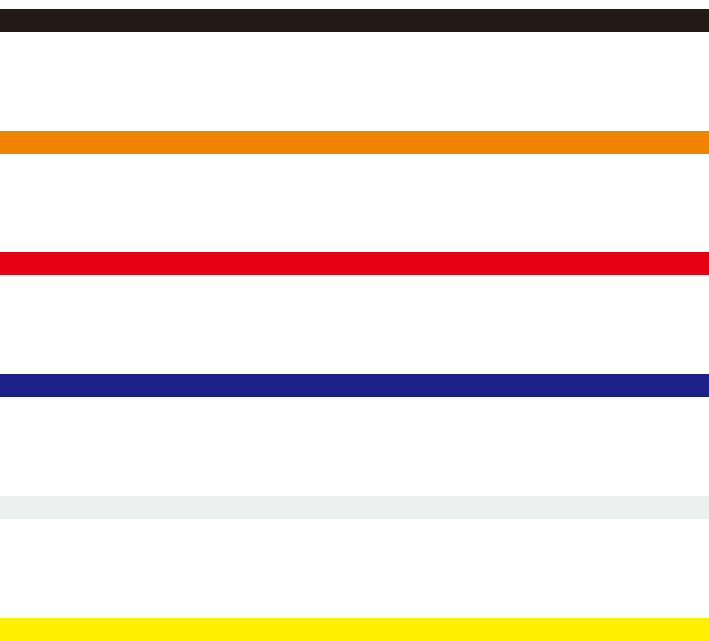

BOWFISHING ARROW

Solid fiberglass arrow shaft for faster and deeper into the water

3.2MM CARBON ALUMINIUM CORE ARROW



High carbon material, cost-effective, accurate shooting accuracy
 Suitable for 15-30 lb recurve bow/compound bow/traditional bow/American hunting bow, etc.

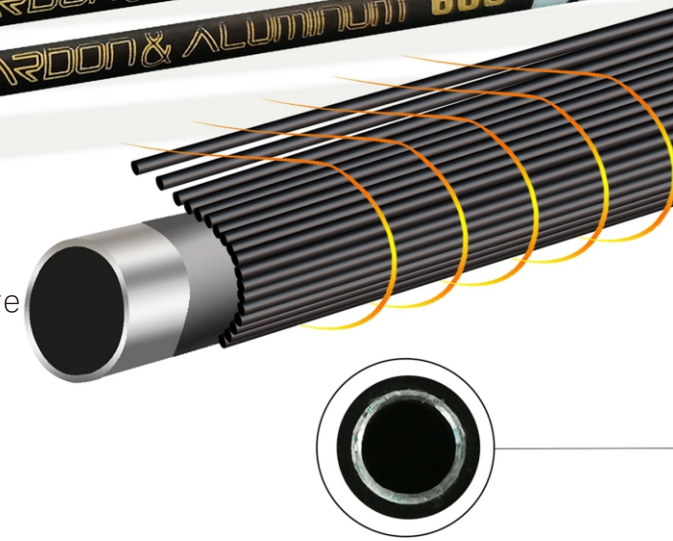

- /// High-strength carbon fiber bonded to a 7075 alloy core
- /// Polished black carbon finish
- /// Straightness: ± 0.001 "
- /// Weight tolerance: ± 1 grains
- /// Components-sold



Stainless steel arrowpoint

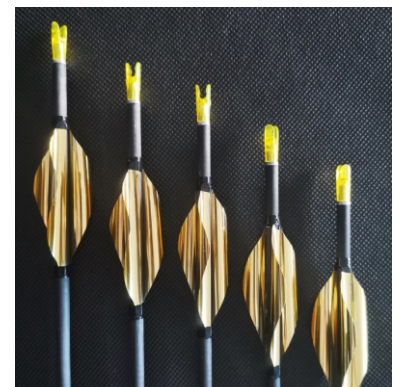

Spiral Feather



Nock Bushing with S nock



S型红色 S型黑色 S型透明橙色 S型透明绿色 S型透明紫色 S型透明红色 S型白色 S型透明蓝色



ARROW INSERT NOCK

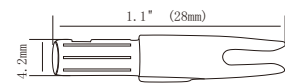

Item number | HI-IN001

Material:
- Plastic

Fit:
- .166" ID Shaft

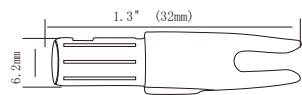

Item number | HI-IN002

Material:
- Plastic

Fit:
- .244" ID Shaft



Arrow Pin Nock

S size is used for 10-14 strands of bowstring
L sizes is used for more than 16 strands of bowstring

- Material: Plastic
- Suit to: 4.2mm, 6.2mm of bushing
- Weight: about 3.0g
- Use: DIY Arrow

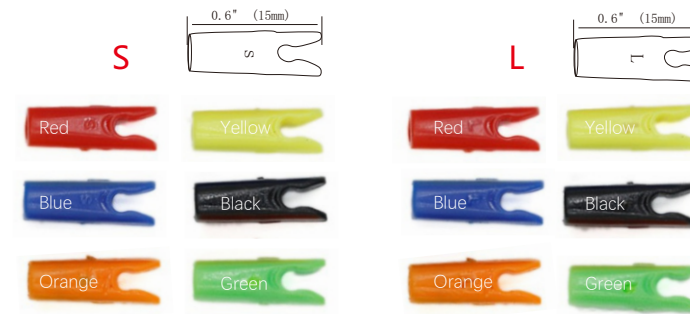

Arrow Nock Bushing

- Material: Aluminum
- Suit to: Pin Nock
- Fits: 4.2mm, 6.2mm Shaft
- Weight: 11.4g 22.0g
- Use: DIY Arrow
- Color: Silver

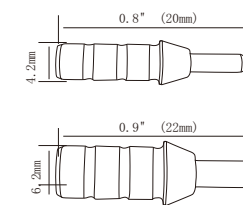

4.2mm

6.2mm



Arrow Pin Nock with Bushing

- Material: Aluminum+Plastic
- Fits: 4.2mm, 6.2mm ID Shaft
- Weight: 11.4g 22.0g
- Use: DIY Arrow

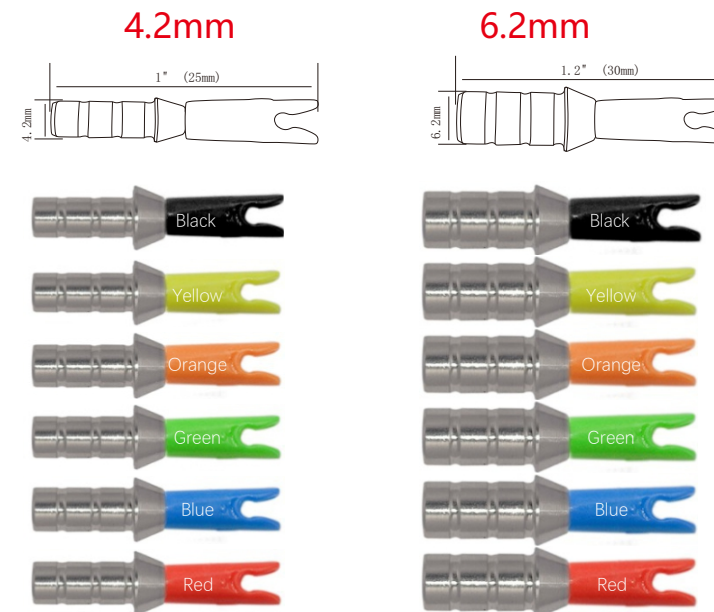

Glue-on Nock

6mm (ID)

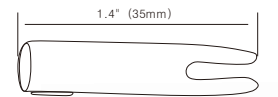

7mm (ID)

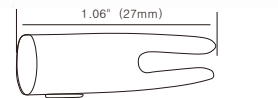

8mm (ID)

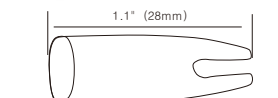

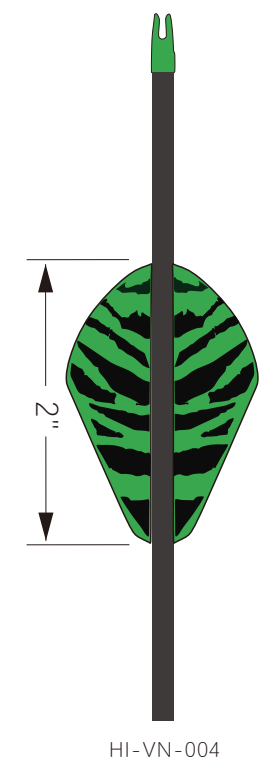
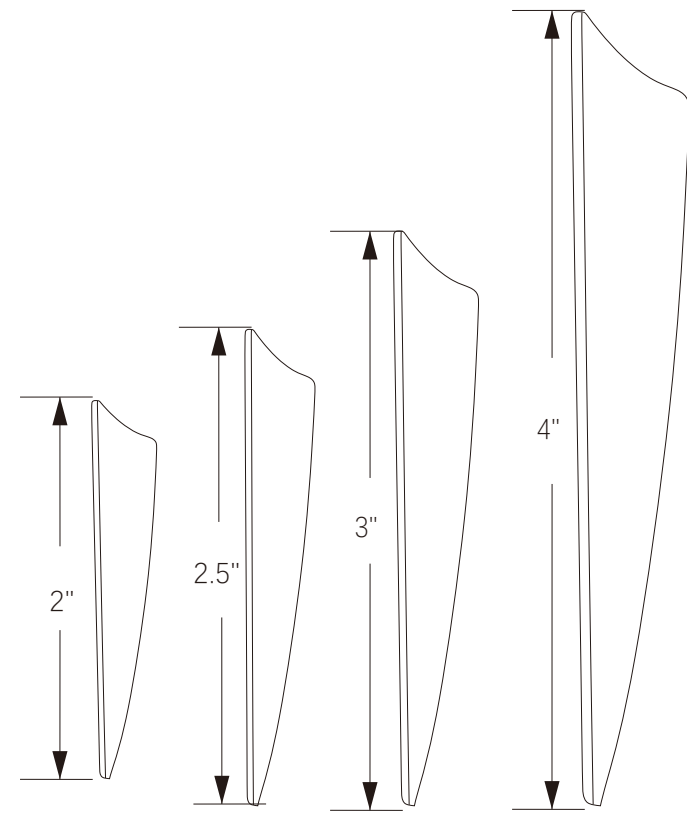
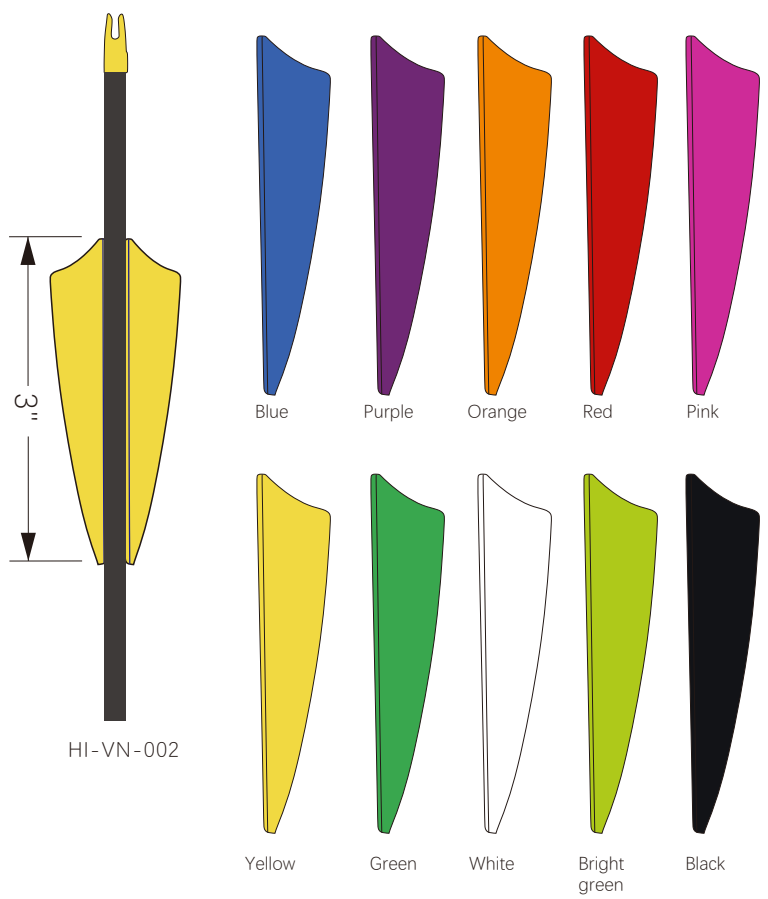
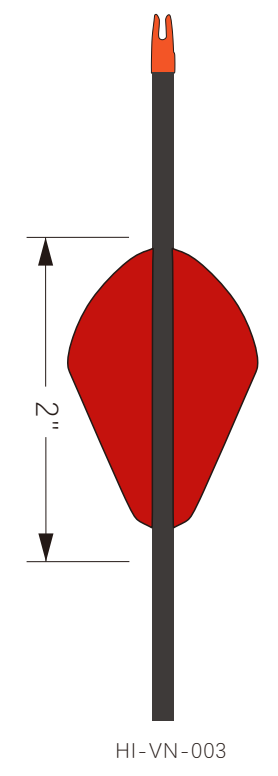
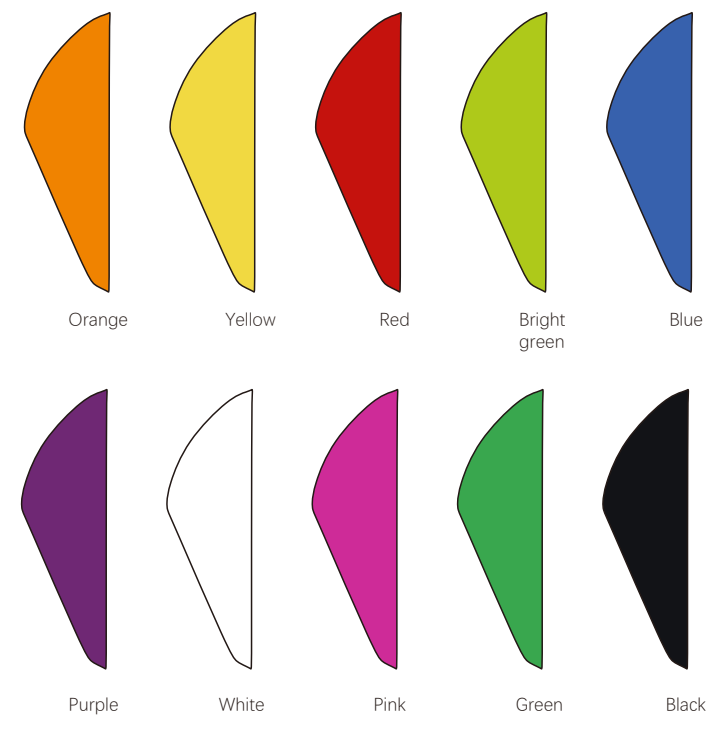
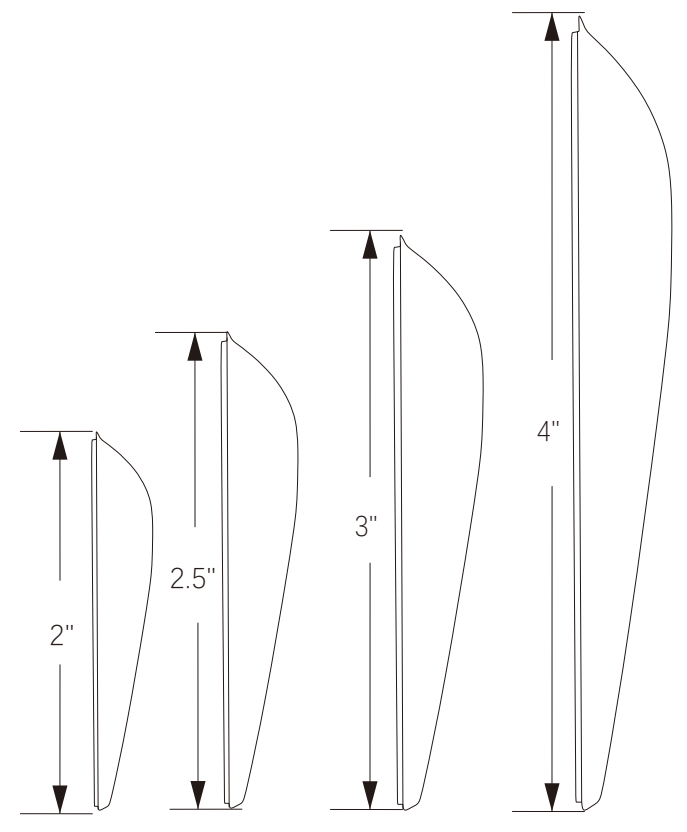
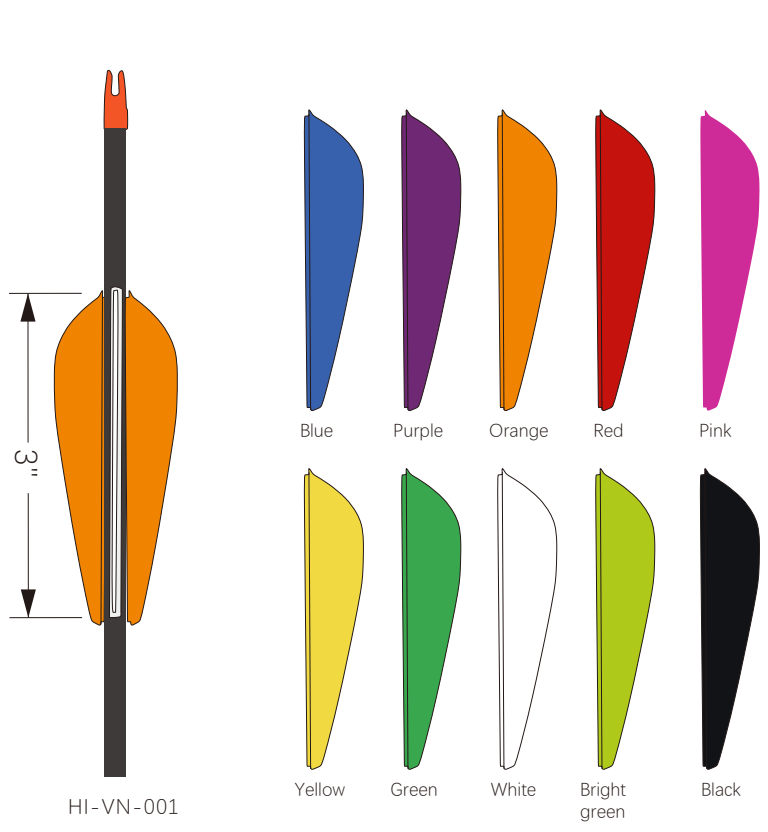

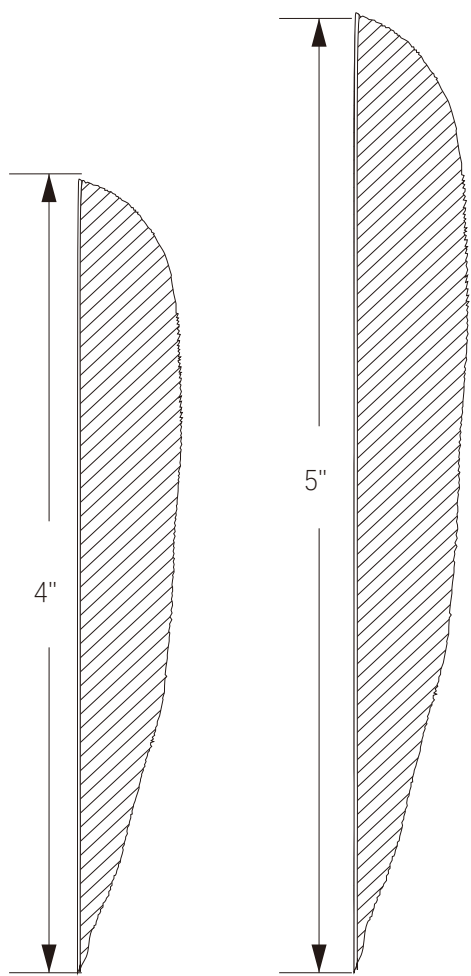
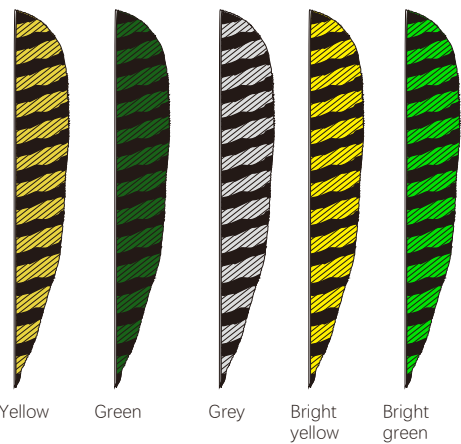
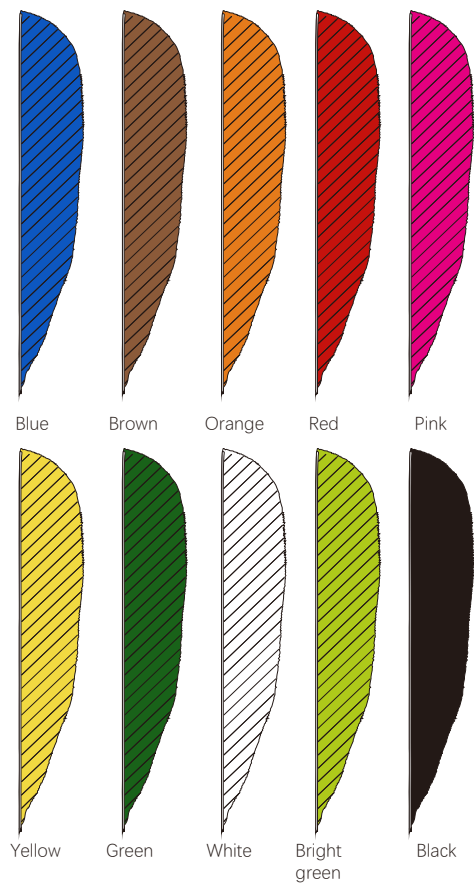
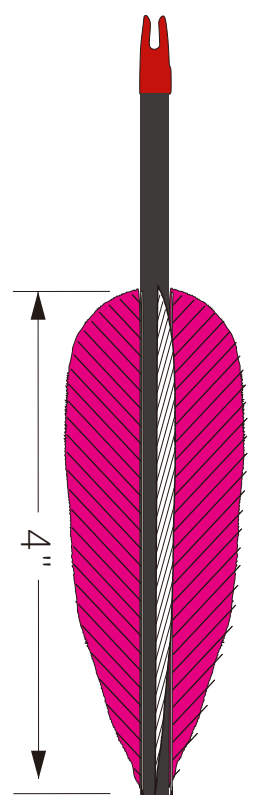

Item number | HI-FV001

Condition:
-100% Brand New

Material:
-Feather

Type:
-Parabolic

Color:
-20 kinds of color

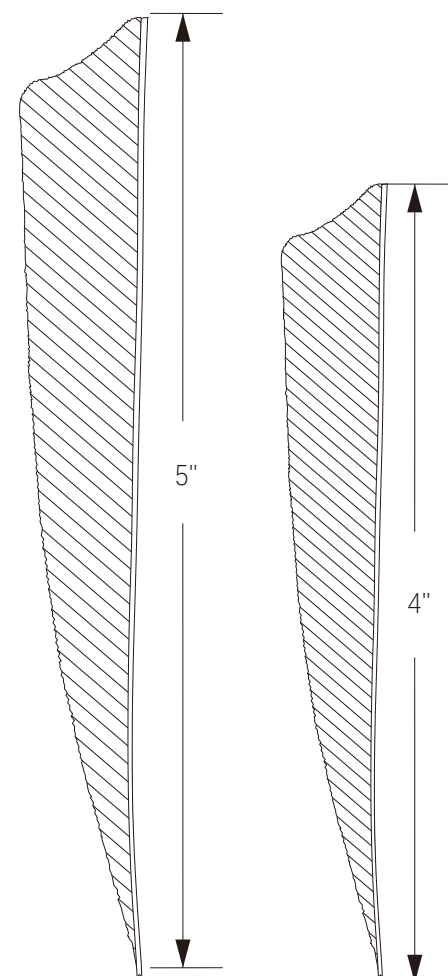

Item number | HI-FV002

Condition:
-100% Brand New

Material:
-Feather

Type:
-Shield

Color:
-20 kinds of color

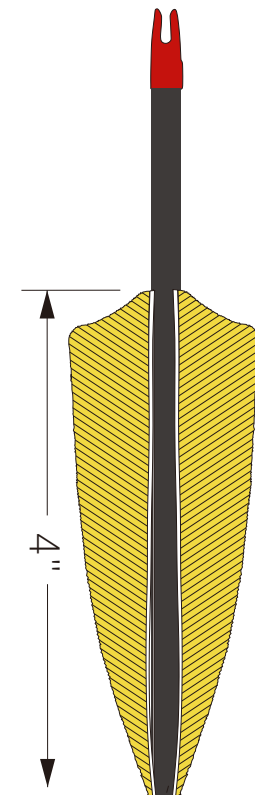

Tungsten Point for X10 and X10 PROTOUR



Material	Weight	Tolerance	Length	Color	Surface Treatment	Usage
Tungsten	100-90-80gr	±0.4 grain	1.4"(35mm)	Natural	Mirror polish	For OD .189" ID .126" Arrow Shaft
	120-110-100gr		1.8"(45.5mm)	Gold	Electroplate	
	140-130-120gr		2.2"(56mm)	Black		
	140-130-120-110-100gr		2.2"(56mm)	Rainbow		

BREAK-OFF: Two or even four break-offs are equipped at the end of point, this system give more flexibility to weight adjustment.

BULLET SHAPE: This classic head shape is used very often in target shooting, it is suitable for any archery event.

MULTICOLOR: Gold, black, and rainbow color coating are made of electroplated titanium, bright in color, having very great wear resistance, not fade after tens of thousands of shots.

GLUE GROOVE: Glue groove under the head for better adhesion to arrow shaft.

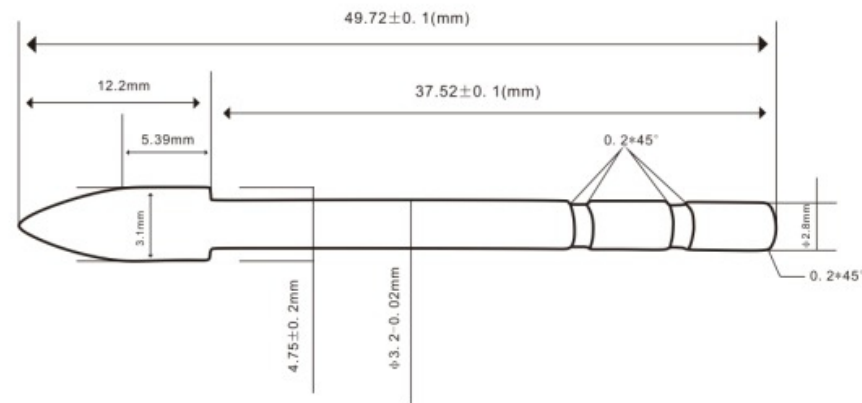

Steel Glue-in Point

Material	Weight	Length	Shaft I.D.	Shaft O.D.	Tolerance
Steel	60gr	1.42"/36mm	.166"/4.2mm	.236"/6mm	±1 grain

Steel Glue-in Point

Material	Weight	Length	Shaft I.D.	Shaft O.D.	Tolerance
Steel	80gr	1.7"/43mm	.166"/4.2mm	.218"/5.5mm	±1 grain
			.166"/4.2mm	.223"/5.8mm	
	100gr	2"/51mm	.166"/4.2mm	.236"/6mm	±1 grain

Stainless Glue-in Break Away Point

Material	Weight	Length	Shaft I.D.	Shaft O.D.	Tolerance
Stainless steel	80-70gr	1.66"/42mm	.166"/4.2mm	.223"/5.8mm	±1 grain
	100-90-80gr	2"/51mm	.166"/4.2mm	.223"/5.8mm	±1 grain
	120-110-100gr	2.4"/60mm	.166"/4.2mm	.256"/6.5mm	±1 grain

Stainless Glue-in Break Away Point

Material	Weight	Length	Shaft I.D.	Shaft O.D.	Tolerance
Stainless steel	100-90-80gr	2.1"/55mm	.166"/4.2mm	.236"/6.0mm	±1 grain
	120-110-100gr	2.6"/67mm	.166"/4.2mm	.244"/6.2mm	±1 grain

Stainless Glue-in Break Away Point

Material	Weight	Length	Shaft I.D.	Shaft O.D.	Tolerance
Stainless steel	150-140-130gr	3.3"/83mm	.166"/4.2mm	.236"/6.0mm	±1 grain





Silver White Nickel Black Nickel

Steel Screw-in Field Point

Weight	Thread	Shaft I.D.	Shaft O.D.	Tolerance
75gr	8-32 UNC	.244" (6.2mm)	.297"(7.54mm)	±1 grain
			.305"(7.74mm)	
			.313"(7.94mm)	
100gr	8-32 UNC	.244" (6.2mm)	.297"(7.54mm)	±1 grain
			.305"(7.74mm)	
			.313"(7.94mm)	
125gr	8-32 UNC	.244" (6.2mm)	.297"(7.54mm)	±1 grain
			.305"(7.74mm)	
			.313"(7.94mm)	

.297 - fit standard carbon (.246 ID) shafts used for hunting;
 .305 - fit weaker spined standard carbon (.246 ID) shafts;
 .313 - fit stiffer spined standard carbon (.246 ID) shafts;

Steel Screw-in Bullet Point



Gold Black

Weight	Thread	Shaft I.D.	Shaft O.D.	Tolerance
75gr	8-32 UNC	.244" (6.2mm)	.297"(7.54mm)	±1 grain
			.305"(7.74mm)	
			.313"(7.94mm)	
100gr	8-32 UNC	.244" (6.2mm)	.297"(7.54mm)	±1 grain
			.305"(7.74mm)	
			.313"(7.94mm)	
125gr	8-32 UNC	.244" (6.2mm)	.297"(7.54mm)	±1 grain
			.305"(7.74mm)	
			.313"(7.94mm)	

.297 - fit standard carbon (.246 ID) shafts used for hunting;
 .305 - fit weaker spined standard carbon (.246 ID) shafts;
 .313 - fit stiffer spined standard carbon (.246 ID) shafts;

Stainless Steel Screw-in Point



Weight	Thread	Shaft I.D.	Shaft O.D.	Tolerance
75gr	8-32 UNC	.244" (6.2mm)	.297"(7.54mm)	±1 grain
			.305"(7.74mm)	
			.313"(7.94mm)	
100gr	8-32 UNC	.244" (6.2mm)	.297"(7.54mm)	±1 grain
			.305"(7.74mm)	
			.313"(7.94mm)	
125gr	8-32 UNC	.244" (6.2mm)	.297"(7.54mm)	±1 grain
			.305"(7.74mm)	
			.313"(7.94mm)	



Glue-on Arrowhead BL6

Material	Height	I.D.	Color
Steel	22.5mm	.236"/6mm	Silver



Glue-on Arrowhead BL7

Material	Height	I.D.	Color
Steel	22.5mm	.276"/7mm	Silver



Glue-on Arrowhead BS601

Material	Height	I.D.	Color
Steel	33mm	.236"/6mm	Silver



Glue-on Arrowhead FS701

Material	Height	I.D.	Color
Steel	34.5mm	.276"/7mm	Silver



Glue-on Arrowhead BS602

Material	Height	I.D.	Color
Steel	36mm	.236"/6mm	Silver



Glue-on Arrowhead FS702

Material	Height	I.D.	Color
Steel	37.4mm	.276"/7mm	Silver



Glue-on Arrowhead FG703

Material	Height	I.D.	Color
Steel	34.5mm	.276"/7mm	Gold



Glue-on Arrowhead FB801

Material	Height	I.D.	Color
Steel	37.4mm	.315"/8mm	Silver
			Black
			Gold
			Nickel

BROADHEADS

Fixed



ITEM	F-01	F-02	F-03	F-04
WEIGHT	100 GRAIN	100 GRAIN	100 GRAIN	100 GRAIN
BLADES	.042" STAINLESS STEEL(2 blades)	.073" STAINLESS STEEL(2 blades)	.031" STAINLESS STEEL(2 blades)	.040" STAINLESS STEEL(4 blades)
FERRULE	ALUMINUM	ALUMINUM	ALUMINUM	ALUMINUM
TIP	/	/	/	/
COLOR	BLACK	BLACK	SILVER/RED/GOLD/BLUE/BLACK	BLACK
CUTTING DIA	1.3"/33mm	1.17"/29mm	0.94"/24mm	1"/26mm



ITEM	F-05	F-06	F-07	F-08
WEIGHT	100 GRAIN	100 GRAIN	100 GRAIN	100 GRAIN
BLADES	.040" STEEL(3 blades)	.040" STEEL(3 blades)	.031" STEEL(3 blades)	.040" STEEL(3 blades)
FERRULE	STEEL	STEEL	STEEL	STEEL
TIP	/	/	/	/
COLOR	SILVER	SILVER/BLACK	SILVER	BLACK
CUTTING DIA	1.15"/29mm	1"/26mm	0.94"/24mm	1.15"/29mm



ITEM	F-09	F-10	F-11	F-12
WEIGHT	100/125 GRAIN	125 GRAIN	100 GRAIN	100 GRAIN
BLADES	.040" STEEL(3 blades)	.031" STAINLESS STEEL(4 blades)	.031" STAINLESS STEEL(6 blades)	.040" STAINLESS STEEL(6 blades)
FERRULE	STEEL	ALUMINUM	ALUMINUM	ALUMINUM
TIP	/	/	/	/
COLOR	SILVER	SILVER	GOLD/BLACK	BLACK
CUTTING DIA	1.3"/33mm	1.2"/30mm	0.9"/22mm	1.3"/29mm



ITEM	F-13	F-14	F-15	F-16
WEIGHT	100/125 GRAIN	100 GRAIN	100/125 GRAIN	100 GRAIN
BLADES	.031" STAINLESS STEEL(4 blades)	.031" STAINLESS STEEL(6 blades)	.031" STAINLESS STEEL(3 blades)	.040" STAINLESS STEEL(3 blades)
FERRULE	ALUMINUM	ALUMINUM	ALUMINUM	ALUMINUM
TIP	/	STEEL	STEEL	STEEL
COLOR	RED/BLACK	RED	SILVER/RED/GOLD/BLUE/ GREEN/BROWN/BLACK	BLACK
CUTTING DIA	1.2"/30mm	1.3"/33mm	0.94"/24mm	1.2"/29mm



ITEM	F-17	F-18	F-19
WEIGHT	100 GRAIN	100 GRAIN	200 GRAIN
BLADES	.031" STAINLESS STEEL(3 blades)	.031" STAINLESS STEEL(6 blades)	.031" STAINLESS STEEL(4 blades)
FERRULE	ALUMINUM	ALUMINUM	ALUMINUM
TIP	STEEL	STEEL	STEEL
COLOR	SILVER/GOLD/GREEN/RED/BLACK	SILVER/RED/GOLD/BLUE/BLACK/PINK/GREEN	SILVER
CUTTING DIA	1.2"/30mm	0.94"/24mm	4"/80mm

Grabbing



ITEM	G-01	G-02	G-03	G-04
MATERIAL	STEEL	STEEL	STEEL	STEEL
WEIGHT	25 GRAIN	100 GRAIN	100 GRAIN	100 GRAIN
COLOR	SILVER	SILVER	SILVER	SILVER/GOLD/BLACK
CUTTING DIA	0.73"/18.5mm	1"/25mm	1"/25mm	0.43"/11mm

Mechanical



ITEM	M-01	M-02	M-03	M-04
WEIGHT	100 GRAIN	100 GRAIN	100 GRAIN	100 GRAIN
BLADES	.031" STAINLESS STEEL(2 blades)	.031" STAINLESS STEEL(2 blades)	.031" STAINLESS STEEL(3 blades)	.040" STAINLESS STEEL(3 blades)
FERRULE	ALUMINUM	ALUMINUM	ALUMINUM	ALUMINUM
TIP	STEEL	STEEL	STAINLESS STEEL	STEEL
COLOR	RED/BLACK	SILVER/RED/GREEN/GOLD/BLACK	BLUE	RED
CUTTING DIA	2.2"/55mm	1.7"/43mm	2.2"/58mm	2"/50mm



ITEM	M-05	M-06	M-07	M-08
WEIGHT	100 GRAIN	100 GRAIN	100 GRAIN	100 GRAIN
BLADES	.031" STAINLESS STEEL(2 blades)	.031" STAINLESS STEEL(2 blades)	.031" STAINLESS STEEL(2 blades)	.040" STAINLESS STEEL(3 blades)
FERRULE	ALUMINUM	STEEL	ALUMINUM	ALUMINUM
TIP	STEEL	STEEL	STEEL	STAINLESS STEEL
COLOR	SILVER	SILVER	SILVER	GOLD
CUTTING DIA	1.9"/48mm	2.23"/58mm	1.8"/46mm	2"/50mm



ITEM	M-09	M-10	M-11	M-12
WEIGHT	100 GRAIN	100 GRAIN	100 GRAIN	100 GRAIN
BLADES	.031" STAINLESS STEEL(2 blades)	.073" STAINLESS STEEL(2 blades)	.031" STAINLESS STEEL(3 blades)	.040" STAINLESS STEEL(2 blades)
FERRULE	STEEL	ALUMINUM	ALUMINUM	ALUMINUM
TIP	STEEL	STAINLESS STEEL	STAINLESS STEEL	STEEL
COLOR	SILVER	RED/BLUE/BLACK/SILVER/GREEN/GOLD	RED/GREEN/BLACK	RED/BLUE/BLACK
CUTTING DIA	2.2"/56mm	1.17"/29mm	2.2"/55mm	1.9"/48mm



ITEM	M-13	M-14	M-15	M-16
WEIGHT	100 GRAIN	100 GRAIN	100 GRAIN	100 GRAIN
BLADES	.031" STAINLESS STEEL(3 blades)	.031" STAINLESS STEEL(3 blades)	.040" STAINLESS STEEL(2 blades)	.031" STAINLESS STEEL(4 blades)
FERRULE	STEEL	ALUMINUM	ALUMINUM	ALUMINUM
TIP	STEEL	STEEL	STEEL	STEEL
COLOR	SILVER	RED/BLUE	BLACK	SILVER/BLACK
CUTTING DIA	1.7"/43mm	1.2"/30mm	1.9"/48mm	1.2"/29mm

Penetration



ITEM	P-01	P-02	P-03	P-04
MATERIAL	STEEL	STEEL	STEEL	STEEL
WEIGHT	200 GRAIN	125 GRAIN	125 GRAIN	150 GRAIN
COLOR	BLACK	BLACK	BLACK	BLACK
CUTTING DIA	0.8"/20mm	0.43"/11mm	0.6"/15mm	0.4"/10mm



ITEM	P-05	P-06
MATERIAL	STEEL	STEEL
WEIGHT	100 GRAIN	100 GRAIN
COLOR	BLACK	BLACK
CUTTING DIA	0.5"/13mm	0.32"/8mm

NOTE:

The broadheads in catalog just a reference that we have ability to produce different types and raw materials broadhead,we mainly focus on the OEM/ODM order.





SUPER BRIGHT LED NOCKS





NEW



These lighted nocks are made of high quality plastic and metal, having a unique look.

Waterproof and shockproof, no assembly required, strong light intensity.

					
ITEM	N-01	N-02	N-03	N-04	N-05
TYPE	WITH ON/OFF SWITCH	SCREW	WITH SCREWDRIVER	WITH ON/OFF SWITCH	WITH ON/OFF SWITCH
WEIGHT	25GRAIN	27GRAIN	29GRAIN	25GRAIN	25GRAIN
FIT SHAFT SIZE	.244"ID SHAFT	.244"ID SHAFT	.244"ID SHAFT	.244"ID SHAFT	.204"ID / .244"ID SHAFT
BATTERY LIFE	24* HOURS	24* HOURS	24* HOURS	24* HOURS	24* HOURS
FEATURE	WATERPROOF	WATERPROOF	WATERPROOF	WATERPROOF	WATERPROOF
PACKAGE	3/5 NOCKS PER PACK	3/5 NOCKS PER PACK	3/5 NOCKS PER PACK	3/5 NOCKS PER PACK	3/5 NOCKS PER PACK
COLORS	RED/BLUE/YELLOW/GREEN/FLASHING (7COLORS)				

				
ITEM	N-06	N-07	N-08	N-09
TYPE	WITH ON/OFF SWITCH	SCREW	WITH SCREWDRIVER	WITH ON/OFF SWITCH
WEIGHT	28GRAIN	28GRAIN	29GRAIN	28GRAIN
FIT SHAFT SIZE	.299"ID SHAFT	.299"ID SHAFT	.299"ID SHAFT	.299"ID SHAFT
BATTERY LIFE	24* HOURS	24* HOURS	24* HOURS	24* HOURS
FEATURE	WATERPROOF	WATERPROOF	WATERPROOF	WATERPROOF
PACKAGE	3/5 NOCKS PER PACK	3/5 NOCKS PER PACK	3/5 NOCKS PER PACK	3/5 NOCKS PER PACK
COLORS	RED/BLUE/YELLOW/GREEN/FLASHING (7COLORS)			

HOOYI
MADE IN CHINA

STABILIZER ACCESSORIES

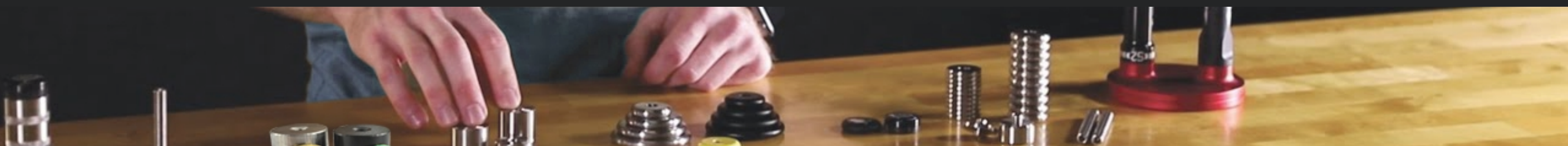

Tungsten Stabilizer Weight

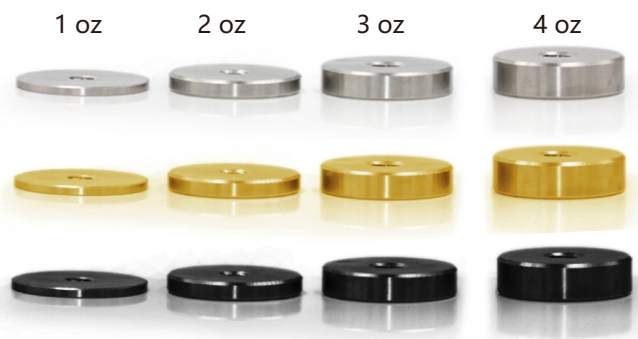

- Material:Tungsten
- Diameter:1.25" / (31.75mm)
- Colors:Silver Gold Black
- Style:Screw-in
- Treads:5/16"-24 UNF 1/4"-20 UNF



Easy Installation

Applicable balance bar, can be use individually or in combination, free to match weight

Stainless Steel Stabilizer Weight

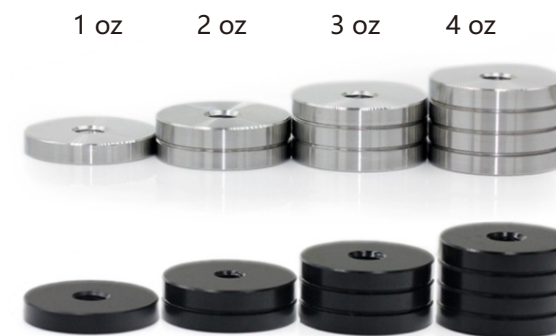

- Material:Stainless Steel
- Diameter:1.24"/31.50mm
- Colors:Natural Black
- Style:Screw-in
- Treads:5/16"-24 UNF 1/4"-20 UNF

Easy installation
Weight directly
Just install it
on the Bow handle lebar



Stabilizer Damper

- Material: Rubber
- Net Weight : 32g (1-1/8 oz.)
- Threads:1/4"-20
- Outer Diameter:30mm/ 1.2"
- Height: 40mm/1.57"
- Available color: Black



Stabilizer V-Bar

- Made of Anodized Machined Aluminum and Stainless Steel
- Solid One Piece Construction
- Diameter:5/16"
- Weight:3.5oz
- Available Model: 40°×0°



ARROW STICKY FEATHER TOOL

Metal Material



Material:
- No.45 Steel and Aluminium

Feather/Van Requirement:
- Shorter than 6 inches

Shaft Requirement:
- Less than 0.375" Diameter

Usage:
- Stick Arrow Vane, DIY Arrow

Weight:
- 0.7 KG including the Packaging

Specification:
- 28*19.5*6.5(cm)

Color:
- Natural; Natural+Gold; Red+Gold; Blue+Gold



Multifunctional Repairer

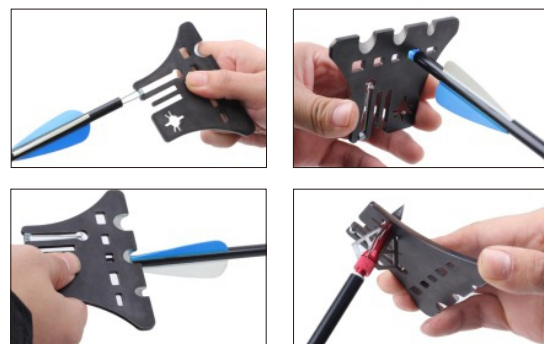
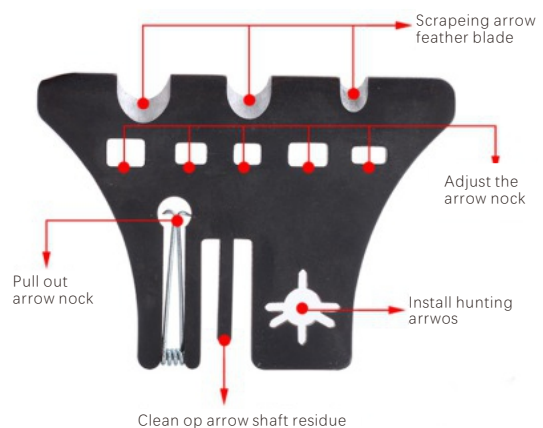

- Scrape arrow feather
- Clean the arrow shaft
- Install broadhead
- Adjust the arrow nock

Fletching Remover

Simple and easy to use
Arrow Feather Scraper



Feature:

1. Designed for removing the vanes from the arrows. It strips vanes and scrapes off glue without damaging the arrow shaft.
2. Equipped with 4 sharp blades, provide high working efficiency, and bring much convenience.
3. Plastic handle is comfortable for grip, also tough and unbreakable.
4. It can works on pure carbon or mixed carbon arrows or aluminum arrows.
5. This fletching remover is a wonderful tool for archery lovers.

ARROW PULLER

- Material:Rubber
- Weight:77g
- Dimension:11×3.4cm
- Color:Red/Blue/Black
- Use:Pull arrows out of the target



- Material:Rubber+Silicone
- Weight:90g
- Dimensions:14×3.8cm
- Color:Orange/Black
- Use:Pull arrows out of the target





Hip Quiver



4-tube hip quiver

Material: Higt-Denier Poly Construction
 Weight : 760g
 Length: 55cm
 Color: Black / Red / Blue
 Style: 4-tube Quiver



3-tube hip quiver

Material: Higt-Denier Poly Construction
 Weight : 460g
 Length: 47cm
 Color: Black / Red / Blue
 Style: 3-tube Quiver

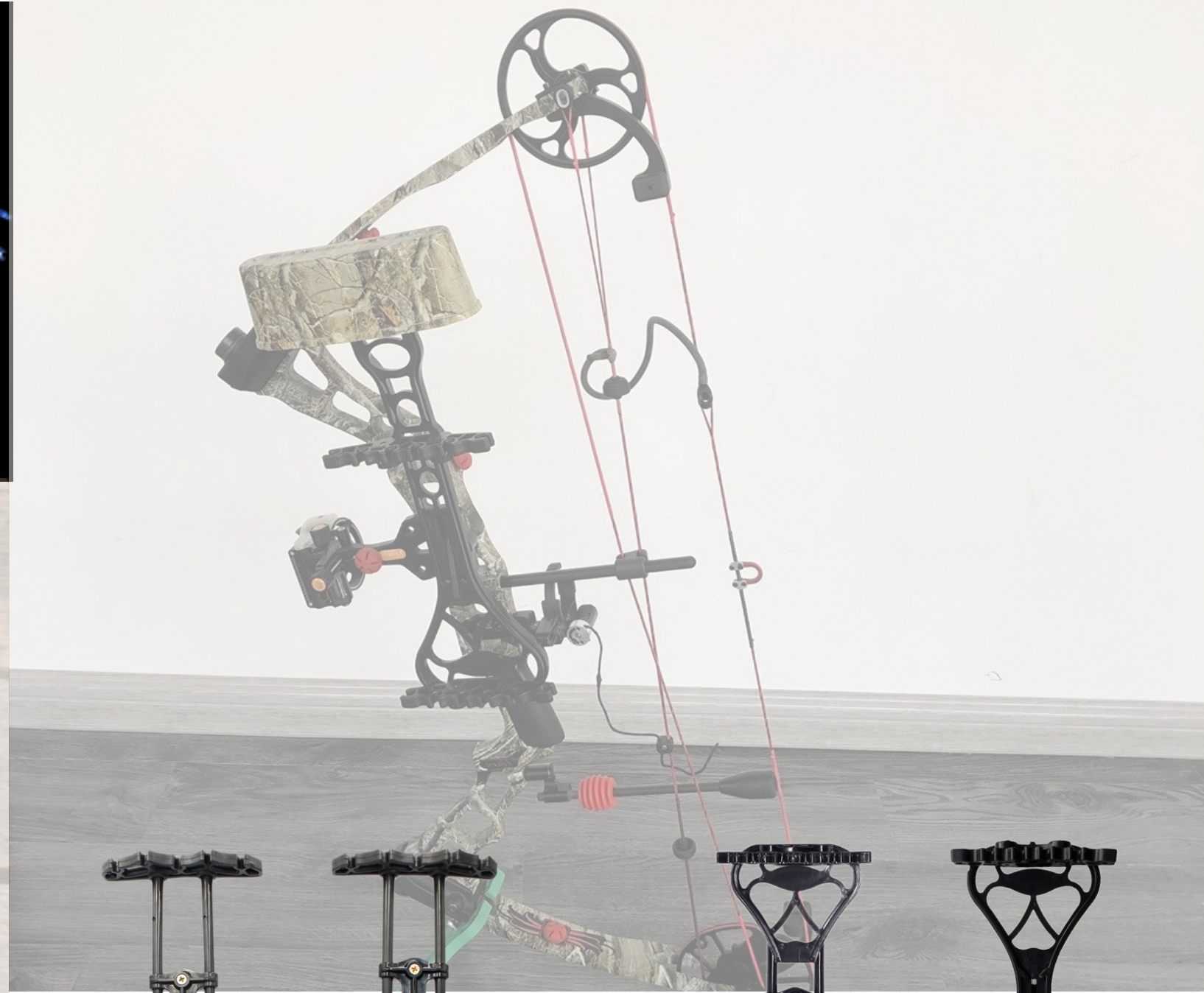

- Products name: arrow quiver
- Material: Rubber Gripper
- Weight: 185g
- Dismensions: 30cm x 14cm x 5cm
- Hold arrow: 5 pcs
- Colors: Black/Camo

- Material: Rubber and Plastic
- Weight: 185g
- Dismensions: 30cm x 14cm x 5cm
- Hold arrow: 6 pcs
- Colors: Black/Camo

Allen Wrench Set



Wrench Size:

- ① 1/4" (6.35mm)
- ② 7/32" (5.65mm)
- ③ 3/16" (4.76mm)
- ④ 5/32" (3.97mm)
- ⑤ 9/64" (3.57mm)
- ⑥ 1/8" (3.18mm)
- ⑦ 7/64" (2.78mm)
- ⑧ 3/32" (2.38mm)
- ⑨ 5/64" (1.98mm)

Alloy material more durable than ordinary steel



Armguard



- Material: Rubber
- Weight : 25g
- Length: 14 cm (5.5")
- Color: Black / Red / Blue

Black Red Blue



Bowstring Silicone Finger Guard

- Size: Length 1 inch(1 Finger), 1.8 inch(2 Finger)
- Diameter:0.46 inch
- Color: Black/Red/Blue
- Material: Silicone



Black Red Blue

Finger Tab

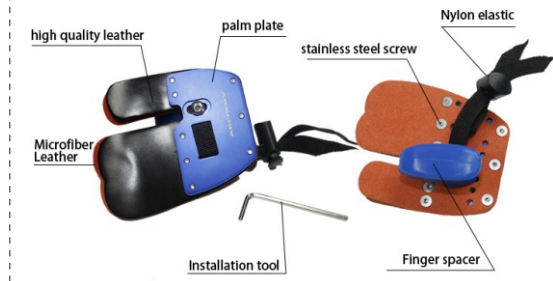

SHOOTING GEAR

